

Product overview

Residual current monitoring

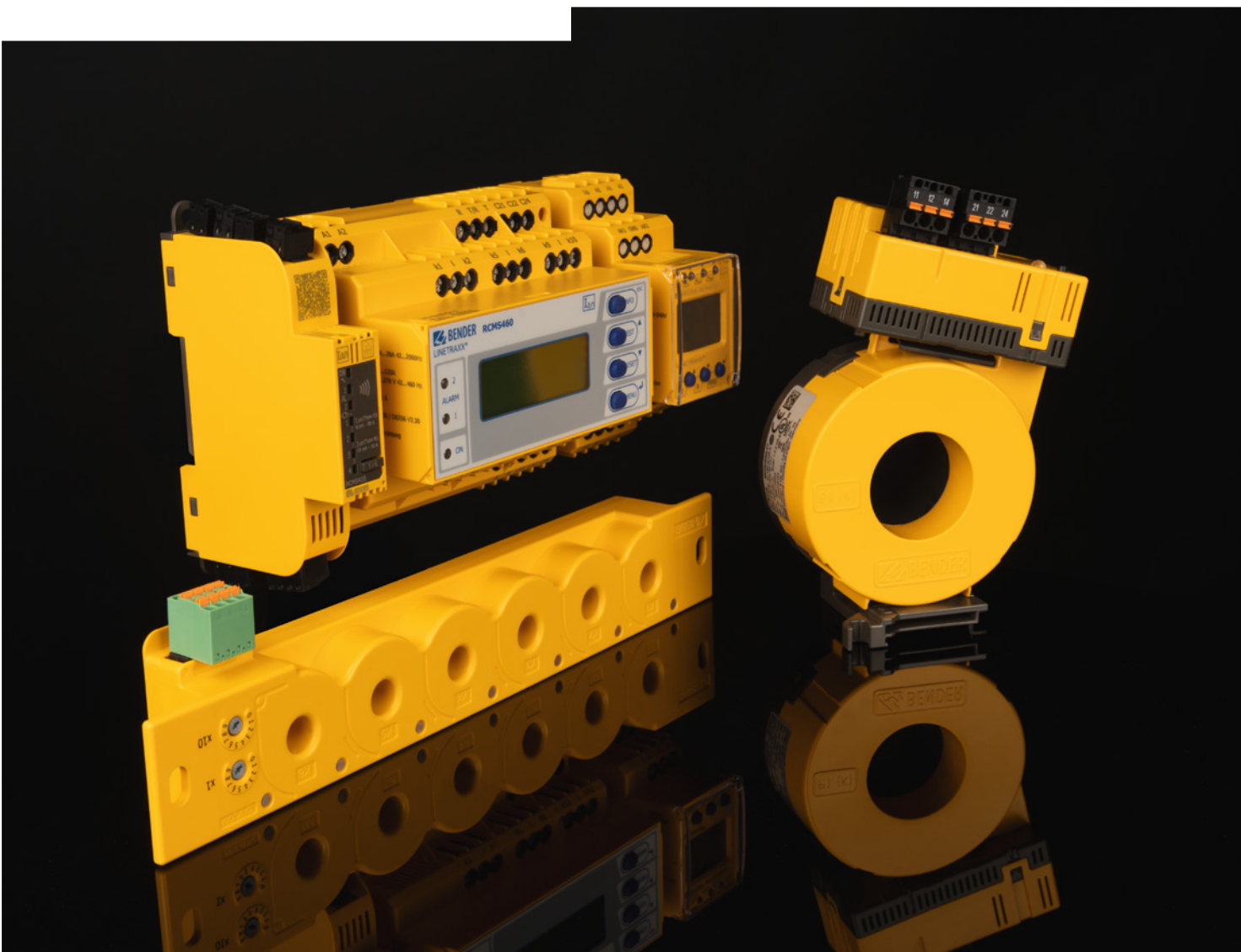

Design the future
of energy



Table of contents

Detecting faults, avoiding shutdowns	4
Residual current monitoring	5
Your benefit from RCM/RCMA/RCMS/MRCD monitoring	7
AC/DC sensitive residual current monitoring modules	8
Residual current monitors RCMB	10
Application example for an RCMS system in an office or a computer room	11
Residual-current monitoring system	12
AC/DC sensitive residual current monitoring system RCMS	16
AC/DC sensitive residual current monitors RCMA	17
Residual current monitors RCM	18
Measuring current transformers for residual current monitors and systems	20
Bender monitoring systems – seamless communication	24
Accessories for residual current monitors and monitoring systems	25
Support in all stages, comprehensive service for your installation	27
POWERSCOUT®: maximum transparency with minimum expenditure	28





Detecting faults, avoiding shutdowns

Signalling instead of shutdown

Reporting critical operating states today to avoid unwanted events tomorrow, such as interruptions to operation, costly damage to property or even physical injuries.

Highest possible installation availability thanks to innovative measuring equipment

Periodic testing and monitoring of electrical installations and equipment is expensive in terms of time and money. Besides that, many installations must not be disconnected because they have to be constantly available. Your time and cost-saving alternative are Bender's residual current monitoring systems for earthed power supplies (TN/TT systems). They monitor electrical installations for residual and/or fault currents in compliance with the

relevant standards and display the current measured value and signal when pre-set response values are exceeded. The continuous residual current monitoring of electrical installations and equipment assists with preventive maintenance in accordance with the German Social Accident Insurance (DGUV) Regulation 3 (formerly BGV A3) or IEC 60364-6.

Safe power supply - in all areas

The application range of residual current monitoring devices and systems extends from data centres, banks, insurances and office buildings, hospitals, traffic infrastructure to energy supply and distribution, broadcasting stations, communication systems and continuous production processes.



Residual current monitoring

increased availability of the installation and reduced costs

Information advantage – a key success factor

Daily international business activities, continuous competitive pressure, the impact of soaring costs and operational availability around the clock – all this requires the maximum possible level of electrical safety for power supply systems in industrial, residential and functional buildings. With continuous monitoring of safety-relevant circuits for fault, residual and operating currents as well as for stray currents, you gain information regarding potential critical operating conditions at an early stage, thus avoiding:

- Danger to persons
- Fire damage and material damage
- EMC interferences

Your benefits:

- Preventive electrical safety for man and machine
- High availability of power supply systems
- Reducing EMC interferences
- Time and cost-optimised maintenance
- Significant reduction of operating costs and cost risks
- Saving potential for the periodic verification according to the German Social Accident Insurance (DGUV) Regulation 3 or IEC 60364-6

Innovative measuring equipment for all types of fault currents

Modern loads, such as variable-speed drives or switched-mode power supplies generate fault currents that have nothing in common with the good old sine wave. Today, a wide range of harmonics and the most versatile wave-forms exist in every power supply system.

The solution: AC/DC sensitive residual current monitoring (true r.m.s. value measurement) and analysis of the harmonics.

Universal residual current monitoring for

- Data centres, EDP equipment and installations
- Banks, insurance companies
- Office and administration buildings
- Hospitals, medical practices
- Power generation and distribution
- Power stations
- TV and broadcasting stations
- Communication systems
- Traffic infrastructure (airports, railway, ships, etc.)
- Continuous production processes (also with variable-speed drives)
- and many more facilities

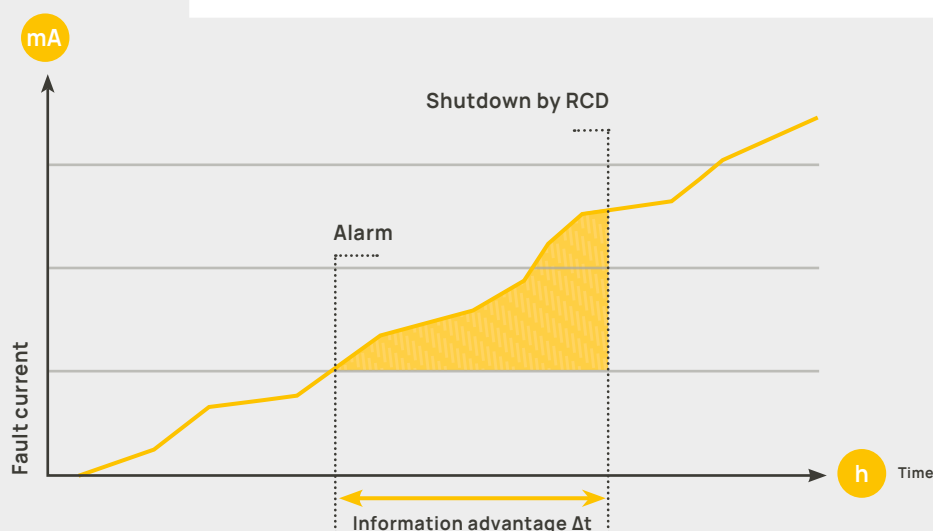

Information advantage thanks to RCM

Differences – RCM, RCMA, RCMB, RCMS

RCMs differ in terms of type, frequency and waveform of the currents they can detect:



RCM series:

Residual current monitors type A in accordance with IEC 60755 for monitoring AC currents and pulsating DC fault currents.



RCMA, RCMB, MRCDB series:

Residual current monitors type B in accordance with IEC 60755 for monitoring AC currents as well as pulsating and smooth DC fault currents.



RCMS series:

Multi-channel residual current monitors types A and B in accordance with IEC 60755 and IEC 62020 for monitoring AC currents as well as pulsating and smooth DC fault currents.

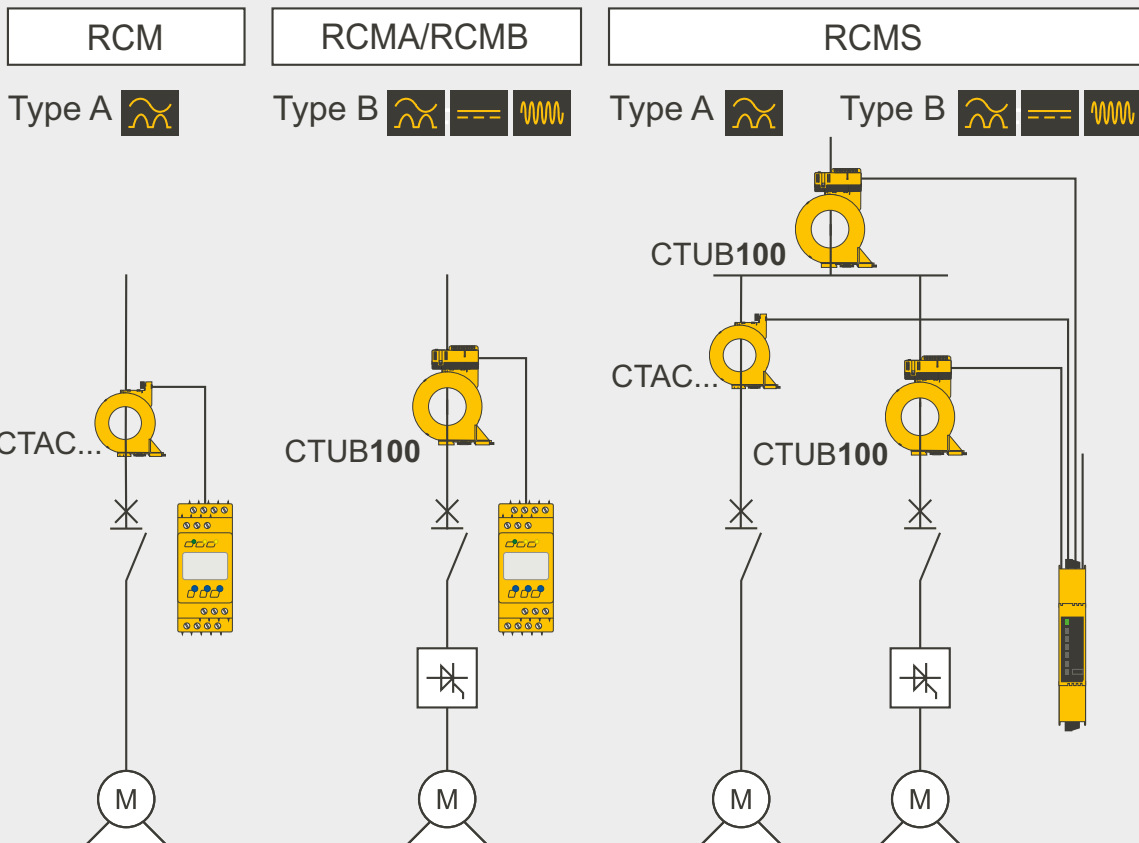

RCM/RCMA/RCMB/RCMS application

Your benefit from monitoring with RCM/RCMA/RCMS/MRCD



Optimised maintenance

- Immediate information through centralised or distributed alarm messages
- Optimised planning of time and personnel resources through complete documentation and precise indication of the fault location
- Fast, preventive intervention through remote diagnostics and remote administration via LAN or WAN network



Increased fire protection

- Detecting potential fire hazards caused by high fault currents as soon as they occur
- Reporting an overload of the N conductor early on
- Avoiding consequential costs resulting from material and ecological damage



Improved economic efficiency

- Maintenance and operating expenses are considerably reduced
- Avoiding expensive and unplanned downtimes of an installation through information at an early stage
- Higher productivity through increased operational reliability
- Cost savings through lower insurance premiums
- Supporting business decisions on investments by recognising weak points in the electrical installation



Comprehensive information

- Clear information on site via LC display
- Transparency of all safety-relevant information through data transfer via bus systems and integration into LAN/WAN networks
- Easy integration into facility management systems via field bus and Ethernet (TCP/IP)
- Cost reduction through the use of existing communication architecture (Ethernet)



Higher operational reliability and safety of an installation

- Preventive safety for the protection of man and machine against the hazards of electric current
- Risks of failure through unexpected operation of safety devices are kept to a minimum
- Monitoring installations and devices continuously for insulation deteriorations instead of spot checks at long intervals
- Detecting potential faults in newly installed electrical installations or during the commissioning of new devices immediately
- Additional safety by monitoring TN-S systems for unwanted N-PE bridges
- Alarm messages either for signalling or switching off

AC/DC sensitive residual current monitoring modules



LINETRAXX® RCMB300 series



Technical data

Rated frequency	DC...100 kHz
Response value	$I_{\Delta n1}$ $I_{\Delta n2}$ 10m A ... 10 A*
Response delay t_{on}	50 ms...60 min
Delay on release t_{off}	0 s...60 min

Description	Dimensions	Type	Art. No.
	Internal diameter (mm)	RCMB301-CTBC... series, circular type, AC/DC sensitive	
Evaluation unit	—	RCMB301	B74043100
Measuring current transformers	ø 20	CTBC20	B98120001
		CTBC20P	B98120002
	ø 35	CTBC35	B98120003
		CTBC35P	B98120004
	ø 60	CTBC60	B98120005
		CTBC60P	B98120006
	ø 120	CTBC120	B98120007
		CTBC120P	B98120020
ø 210	CTBC210	B98120008	
	CTBC210P	B98120021	

LINETRAXX® MRCDB300 series



Technical data

Rated frequency	DC...100 kHz
Response value	$I_{\Delta n1}$ $I_{\Delta n2}$ 10m A ... 10 A*
Response delay t_{on}	0 s...60 min
Delay on release t_{off}	0 s...60 min

	Internal diameter (mm)	MRCDB30...-CTBC... series, circular type, AC/DC sensitive	
Electronic module for the protection of people	—	MRCDB301	B74043120
Electronic module for fire protection	—	MRCDB302	B74043121
Electronic module for the protection of people, fire protection and protection of an installation (freely configurable)	—	MRCDB303	B74043122
Electronic module for the protection of people for applications with pulsed, very high peak-load currents.	—	MRCDB305	B74043125
Measuring current transformers	ø 20	CTBC20	B98120001
		CTBC20P	B98120002
	ø 35	CTBC35	B98120003
		CTBC35P	B98120004
	ø 60	CTBC60	B98120005
		CTBC60P	B98120006
	ø 120	CTBC120	B98120007
		CTBC120P	B98120020
ø 210	CTBC210	B98120008	
	CTBC210P	B98120021	

*dependent on the connected measuring current transformer

Example of a module combination (MRCDB/RCMB)



+



=



Residual current monitors RCMB



Product



LINETRAXX® RCMB330

Type of distribution system	TN/TT	✓
	IT	—
Residual currents		✓
		✓
		✓
Rated frequency		Hz
Response value	$I_{\Delta n1}$ $I_{\Delta n2}$	DC ... 100 kHz
Operating time		≤ 500 ms ($1 \times I_{\Delta n}$), ≤ 230 ms ($2 \times I_{\Delta n}$), ≤ 100 ms ($5 \times I_{\Delta n}$)
Response delay t_{on}		0 s...60 min (freely configurable), (0 s)*
Delay on release t_{off}		0 s...60 min (freely configurable), (1 s)*
Mounting	DIN rail (clip required for mounting)	—
	Screw mounting	✓
Interface	BMS	—
	Modbus	RTU

()* factory settings

Ordering information

Supply voltage U_s	Variant	Type	Art. No.
DC 24 V (19.2...28.8 V)	Modbus RTU	RCMB330	B74043160

Ordering information

Description	Art. No.
RS-485-USB interface converter	B95012045

Suitable system components

Using the listed mains parts is recommended. Use of a surge protection device is mandatory for these mains parts.

Description	Max. no. of connected current transformers	Type	Art. No.
Power supply	4	STEP-PS/1 AC/24 DC/0.5	B94053110
	14	STEP-PS/1 AC/24 DC/1.75	B94053111
	34	STEP-PS/1 AC/24 DC/4.2	B94053112

Application example for an RCMS system in an office or a PC room

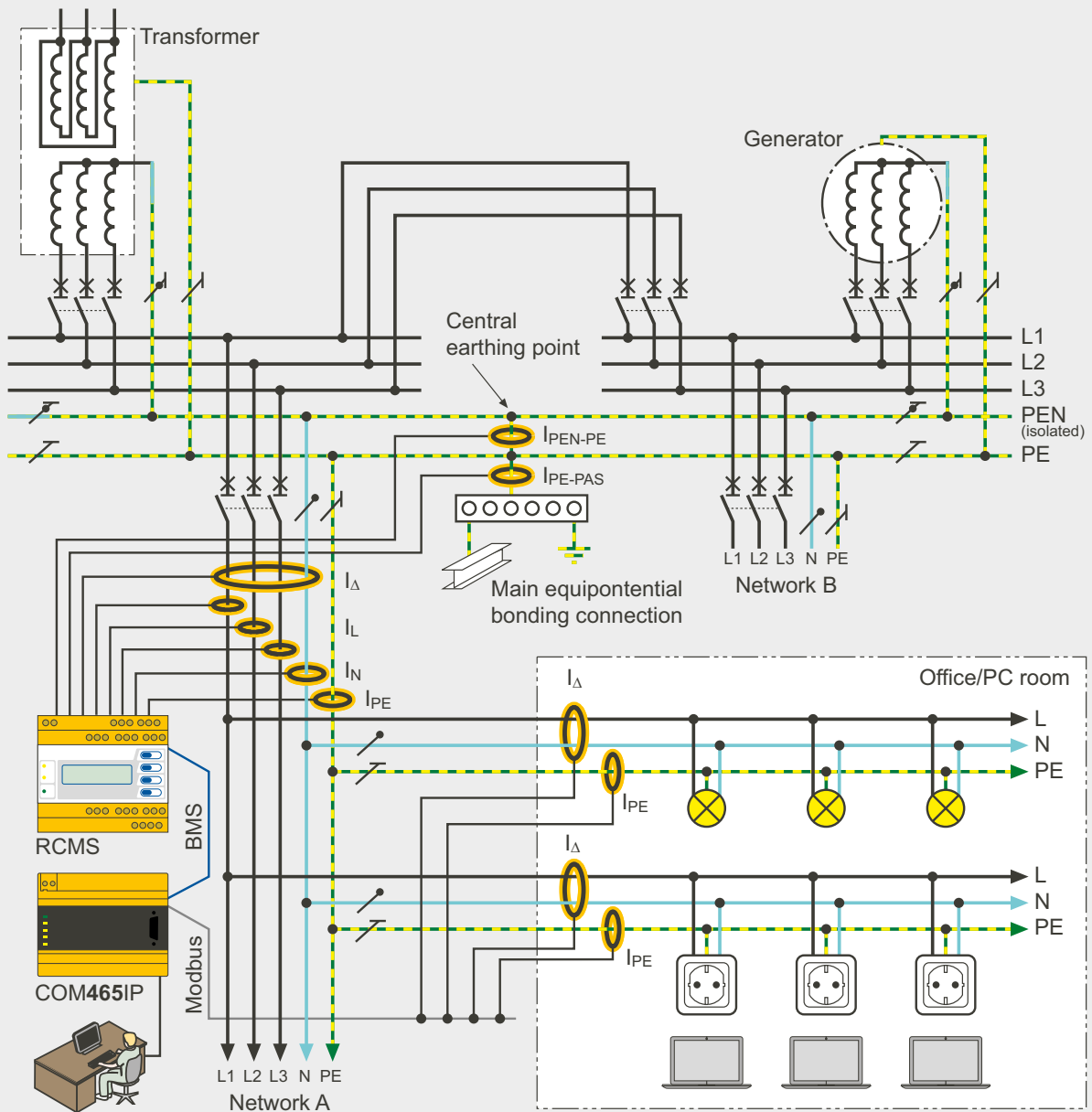

Power supply in an office building



Legend

- I_{Δ} = Residual/fault current
- I_L = Current in the phase
- I_N = Current in the N conductor
- I_{PE} = Current in the PE conductor (PE)
- I_{PEN-PE} = Current in the PEN-PE bridge
- I_{PE-PAS} = Current in the main earth rail ("HES")

Note: When the TN-S system with multiple feed is operated in normal mode, the PEN conductor is used only as a neutral conductor.





Residual current monitoring system

Products

Type of distribution system	TN/TT	
	IT	
Residual currents		
		
		
	Parameter setting function	
	Master/slave	
	Address range	
Measuring circuit	Measuring channels per device	
	W..., WR..., WS..., W...AB, W...F series measuring current transformers	
	CT monitoring	
	Frequency range: AC/DC sensitive	
	Frequency range: pulsed DC sensitive	
	Rated residual operating current $I_{\Delta n2}$ (alarm)	AC/DC sensitive (type B)
		Pulsed DC sensitive (type A)
		Pulsed DC sensitive 42 Hz... 2000 Hz (type A) for channels 9...12 (RCMS4x0-D4/-L4)
	Rated residual operating current $I_{\Delta n1}$ (prewarning)	
	Function selectable per channel: off, <, >, I/O	
	Adjustable cut-off frequency for the protection of people, of the installation and against fire	
	Preset function for $I_{\Delta n2}$ and I/O	
	Hysteresis	
Factor for additional CT		
Switching elements	Common alarm relay for all channels	
	Alarm relay per channel	
Time response	Start-up delay 0...99 s	
	Response delay, delay on release 0...999 s	
	Operating time at	$I_{\Delta n} = 1 \times I_{\Delta n2}: \leq 180 \text{ ms}$
		$I_{\Delta n} = 5 \times I_{\Delta n2}: \leq 30 \text{ ms}$
Displays, memory	Analysis of the harmonics (I_{Δ} , DC, THD)	
	History memory for 300 data records	
	Data logger for 300 data records per channel	
	Internal clock	
	Password	
	Language English, German, French, Swedish	
	Backlit graphic LC display	
	7-segment display and LED line	
Mounting	DIN rail (clip required for mounting)	
	Screw mounting	
	Mounting clip	

* Factory setting / ** only in conjunction with RCMS4xx-D, MK2430 or COM465IP



	 LINETRAXX® RCMS410	 LINETRAXX® RCMS460-D	 LINETRAXX® RCMS460-L	 LINETRAXX® RCMS490-D	 LINETRAXX® RCMS490-L
✓	✓	✓	✓	✓	✓
—	—	—	—	—	—
✓	✓	✓	✓	✓	✓
✓	✓	✓	✓	✓	✓
✓	✓	✓	✓	✓	✓
✓	✓	—	✓	—	—
✓	✓	✓	✓	✓	✓
1...90	1...90	1...90	1...90	1...90	1...90
4	12	12	12	12	12
✓	✓	✓	✓	✓	✓
✓	✓	✓	✓	✓	✓
DC, 15 Hz...20 kHz	0 Hz ...2 kHz	0 Hz ...2 kHz	0 Hz ...2 kHz	0 Hz ...2 kHz	0 Hz ...2 kHz
15 Hz...20 kHz	42 Hz...2 kHz	42 Hz...2 kHz	42 Hz...2 kHz	42 Hz...2 kHz	42 Hz...2 kHz
10 mA...10 A	10 mA...10 A	10 mA...10 A	10 mA...10 A	10 mA...10 A	10 mA...10 A
6 mA...30 A	6 mA...20 A	6 mA...20 A	6 mA...20 A	6 mA...20 A	6 mA...20 A
—	100 mA...125 A	100 mA...125 A	100 mA...125 A	100 mA...125 A	100 mA...125 A
10...100 % x I _{Δn} (50 %)*	10...100 %, min. 5 mA	10...100 %, min. 5 mA	10...100 %, min. 5 mA	10...100 %, min. 5 mA	10...100 %, min. 5 mA
✓	✓	✓	✓	✓	✓
✓	✓	**	✓	✓	**
✓	✓	✓	✓	✓	✓
10...25 % (15 %)*	2...40 %	2...40 %	2...40 %	2...40 %	2...40 %
✓	✓	✓	✓	✓	✓
—	2 x 1 changeover contact	2 x 1 changeover contact	2 x 1 changeover contact	2 x 1 changeover contact	2 x 1 changeover contact
—	—	—	12 x 1 N/O contact	12 x 1 N/O contact	12 x 1 N/O contact
✓	✓	✓	✓	✓	✓
✓	✓	✓	✓	✓	✓
✓	✓	✓	✓	✓	✓
✓	✓	✓	✓	✓	✓
✓	✓	**	✓	✓	**
—	✓	—	✓	✓	—
—	✓	—	✓	✓	—
✓	✓	—	✓	✓	—
—	✓	—	✓	✓	—
—	✓	—	✓	✓	—
—	✓	—	✓	✓	—
—	✓	—	✓	✓	—
—	—	✓	—	—	✓
✓	✓	✓	✓	✓	✓
✓	✓	✓	✓	✓	✓
✓ (Optionally)	✓ (Optionally)	✓ (Optionally)	✓ (Optionally)	✓ (Optionally)	✓ (Optionally)

Residual current monitoring system



The RCMS system is a multi-channel residual current monitoring system designed to monitor up to 12 measuring points or measuring channels per device or up to 1080 channels when several devices are interconnected. The RCMS system is suitable for alternating currents, pulsating and smooth direct currents, depending on the type of measuring current transformer.

Ordering information for RCMS410

Type	Supply voltage U_s	Usable with measuring CT		Factory installed configurable	Activated function modules ***	Art. No.
		Type A Type F	Type B Type B+			
RCMS410-24	DC 24 V	X	(X) with function module A	Factory settings function modules	Customised (A, B, C can be bought later)	B84604040
		X	X	—	A (B and C can be bought later)	B84604041
		X	X	—	A, B, C	B84604042

*** Function modules: A: AC/DC sensitive measuring and evaluation of values; B: Harmonic analysis (FFT); C: Connection of type A external transformers

Ordering information RCMS460/490-D

Residual current measurement		Common alarm relay for all channels	Alarm relay per channel	4 channels for load current measurement	Supply voltage U_s	Type	Art. No.
pulsed DC sensitive	AC/DC sensitive						
6 mA...20 A	10 mA...10 A	2 x 1 changeover contact	—	—	AC 16...72 V, 42...460 Hz DC 16...94 V	RCMS460-D-1	B94053001
					AC 70...276 V, 42...460 Hz/ DC 70...276 V	RCMS460-D-2	B94053002
					AC 16...72 V, 42...460 Hz DC 16...94 V	RCMS460-D4-1	B94053009
					AC 70...276 V, 42...460 Hz/ DC 70...276 V	RCMS460-D4-2	B94053010
		12 x 1 N/O contact	—	—	AC 16...72 V, 42...460 Hz DC 16...94 V	RCMS490-D-1	B94053005
					AC 70...276 V, 42...460 Hz/ DC 70...276 V	RCMS490-D-2	B94053006
					AC 16...72 V, 42...460 Hz DC 16...94 V	RCMS490-D4-1	B94053011
					AC 70...276 V, 42...460 Hz/ DC 70...276 V	RCMS490-D4-2	B94053012

Ordering information RCMS460/490-L

Current measurement		Common alarm relay for all channels	Alarm relay per channel	Supply voltage U_s	Type	Art. No.
pulsed DC sensitive	AC/DC sensitive					
6 mA...20 A	10 mA...10 A	2 x 1 changeover contact	—	AC 16...72 V, 42...460 Hz/DC 16...94 V	RCMS460-L-1	B94053003
				AC 70...276 V, 42...460 Hz/DC 70...276 V	RCMS460-L-2	B94053004
		2 x 1 changeover contact	12 x 1 N/O contact	AC 16...72 V, 42...460 Hz/DC 16...94 V	RCMS490-L-1	B94053007
				AC 70...276 V, 2...460 Hz/DC 70...276 V	RCMS490-L-2	B94053008

Application examples

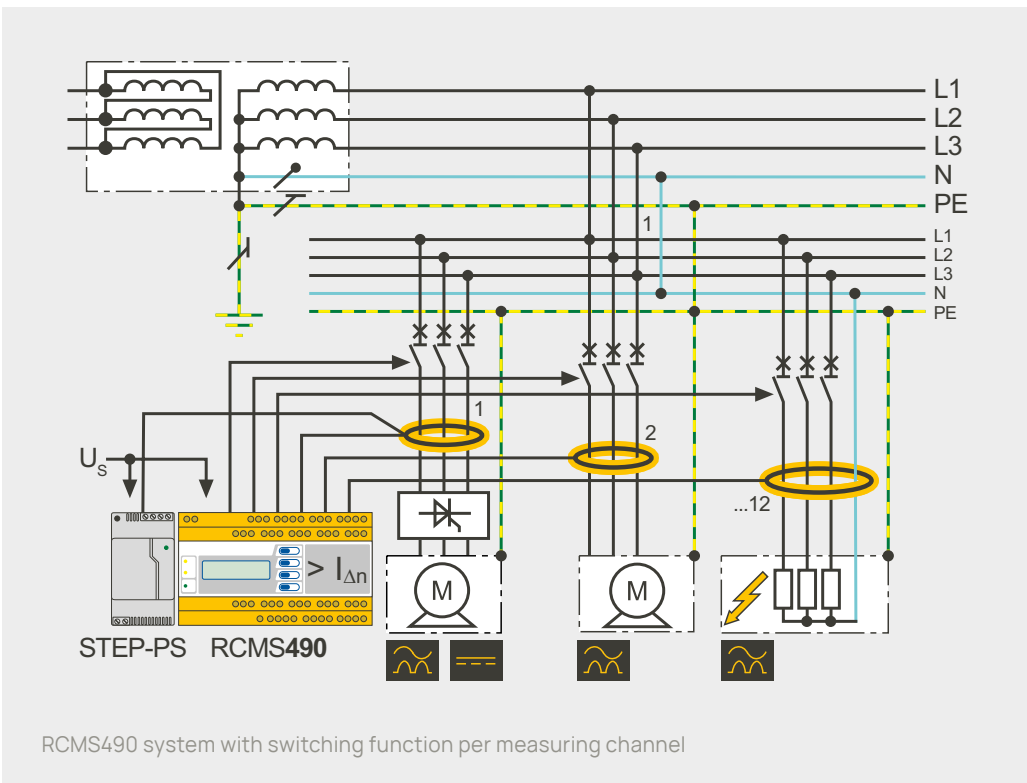
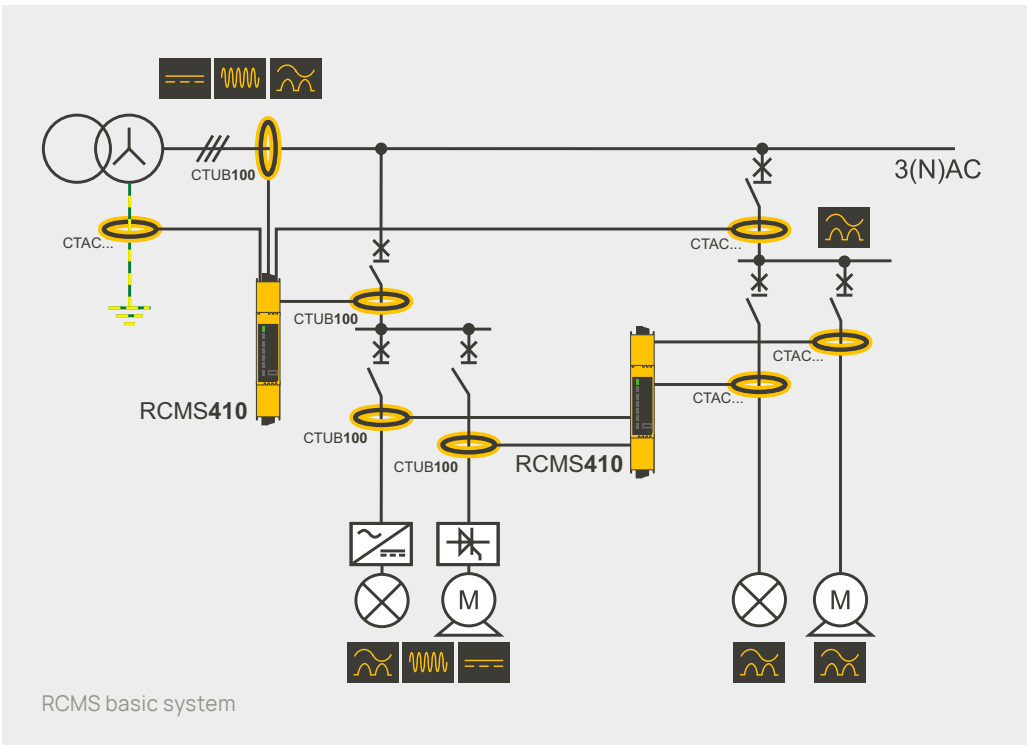

AC/DC sensitive residual current monitoring system RCMS



Product



LINETRAXX® RCMS150

Special applications

Monitoring of final circuits, acc. to the German Social Accident Insurance (DGUV) regulation 3 or IEC 60364-6

Type of distribution system

TN/TT



IT



Residual currents



Rated frequency

0...2000 Hz

Number of measuring channels

6/virtually 12

Internal diameter of the measuring channels (mm)

10

Response value

$I_{\Delta n1}$

50...100 % x $I_{\Delta n2}$

$I_{\Delta n2}$

3...300 mA (type B)/3...300 mA (DC)

Response delay t_{on}

0...600 s

Start-up delay t

0.5...600 s

Delay on release t_{off}

0...600 s

Operating principle of the alarm relays



Displays

Power-on LED



Alarm LEDs



Mounting

DIN rail



Screw mounting (clip required for mounting)



Mounting clip

✓ (Optionally)

Ordering information

Nominal supply voltage U_s

Type

Art. No.

DC

24 V





RCMS150

B94053025



AC/DC sensitive residual current monitors RCMA



Product			
		LINETRAXX® RCMA420	LINETRAXX® RCMA423
Type of distribution system	TN/TT	✓	✓
	IT	—	—
Residual currents		✓	✓
		✓	✓
		✓	✓
Rated frequency		0...2000 Hz	0...2000 Hz
Number of measuring channels		1	1
Response value	$I_{\Delta n1}$	50...100 % $\times I_{\Delta n2}$	50...100 % $\times I_{\Delta n2}$
	$I_{\Delta n2}$	10...500 mA	30 mA...3 A
Operating time		$\leq 180 \text{ ms } (1 \times I_{\Delta n1}), \leq 30 \text{ ms } (5 \times I_{\Delta n1})$	$\leq 180 \text{ ms } (1 \times I_{\Delta n1}), \leq 30 \text{ ms } (5 \times I_{\Delta n1})$
Response delay t_{on}		0...10 s	0...10 s
Start-up delay t		0...10 s	0...10 s
Delay on release t_{off}		0...300 s	0...300 s
Alarm relay	Main alarm	1 changeover contact	1 changeover contact
	Prewarning	1 changeover contact	1 changeover contact
	Operating principle	N/C operation or N/O operation	N/C operation or N/O operation
Displays	LC display	✓	✓
	Power-on LED	✓	✓
	Alarm LEDs	✓	✓
	Connection, external measuring instrument	✓ (Option)	✓ (Option)
Mounting	DIN rail (clip required for mounting)	✓	✓
	Screw mounting	✓	✓
	Mounting clip	✓ (Optionally)	✓ (Optionally)

Ordering information

Response range $I_{\Delta n}$	Supply voltage ¹⁾ U_s	Type	Art. No.	
			Screw-type terminal	Push-wire terminal
10...500 mA	AC 16...72 V, 42...460 Hz/DC 9.6...94 V	RCMA420-D-1	B94043001	B74043001
	AC 70...300 V, 42...460 Hz/DC 70...300 V	RCMA420-D-2	B94043002	B74043002
30 mA...3 A	AC 16...72 V, 42...460 Hz/DC 9.6...94 V	RCMA423-D-1	B94043023	B74043023
	AC 70...300 V, 42...460 Hz/DC 70...300 V	RCMA423-D-2	B94043025	B74043025

¹⁾ Absolute values

Residual current monitors RCM



Product



LINETRAXX® RCM420

Type of distribution system	TN/TT IT	✓ —
Residual currents		✓
		—
		—
Rated frequency		42...2000 Hz
Number of measuring channels		1
Response value	$I_{\Delta n1}$	$50...100\% \times I_{\Delta n2}$
	$I_{\Delta n2}$	10 mA...10 A
Operating time		$\leq 180\text{ ms } (1 \times I_{\Delta n1}), \leq 30\text{ ms } (5 \times I_{\Delta n1})$
Response delay t_{on}		0...10 s
Start-up delay t		0...10 s
Delay on release t_{off}		0...300 s
Alarm relay	Main alarm	1 changeover contact
	Prewarning	1 changeover contact
	Operating principle	N/C operation or N/O operation
Displays	LC display	✓
	Power-on LED	✓
	Alarm LEDs	✓
	Connection, external measuring instrument	✓ (Option)
Mounting	DIN rail (clip required for mounting)	✓
	Screw mounting	✓
	Mounting clip	✓ (Optionally)

Ordering information

Response range $I_{\Delta n}$	Supply voltage ¹⁾ U_s	Type	Art. No.	
			Screw-type terminal	Push-wire terminal
10 mA...10 A	AC 16...72 V, 40...460 Hz/DC 9.6...94 V	RCM420-D-1	B94014001	B74014001
	AC 70...300 V, 40...460 Hz/DC 70...300 V	RCM420-D-2	B94014002	B74014002

¹⁾ Absolute values

Application examples

RCMs monitor residual currents or fault currents in earthed systems (TN, TT systems) and are mainly used in installations where an alarm should be provided but a shutdown should be prevented in the event of a fault. RCMs are suitable for alternating currents and pulsating DC currents.

They can also be used in combination with existing protective devices for the monitoring and indication of a present fault current. For that purpose, response values and response times are adjustable.

Due to modern loads, an RCM type A is used only in exceptional cases!

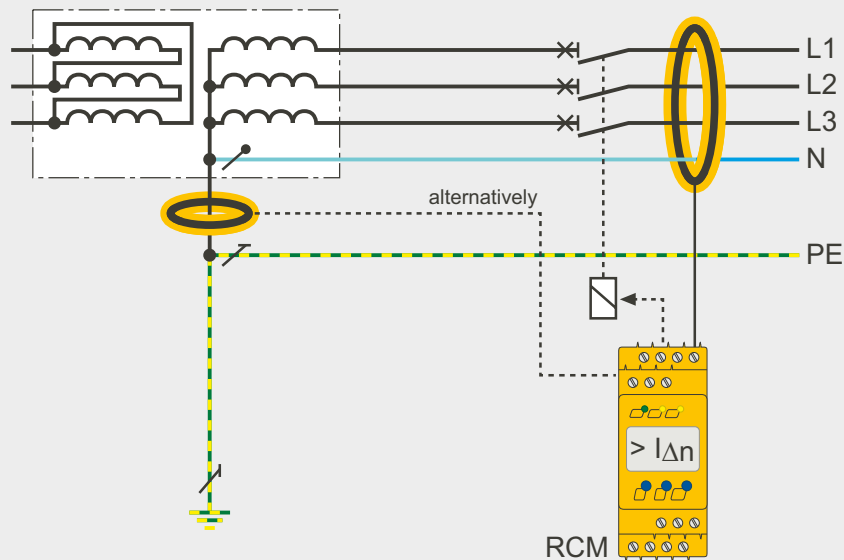

Monitoring of an incoming supply for fault currents (phases, N-conductor or PE)

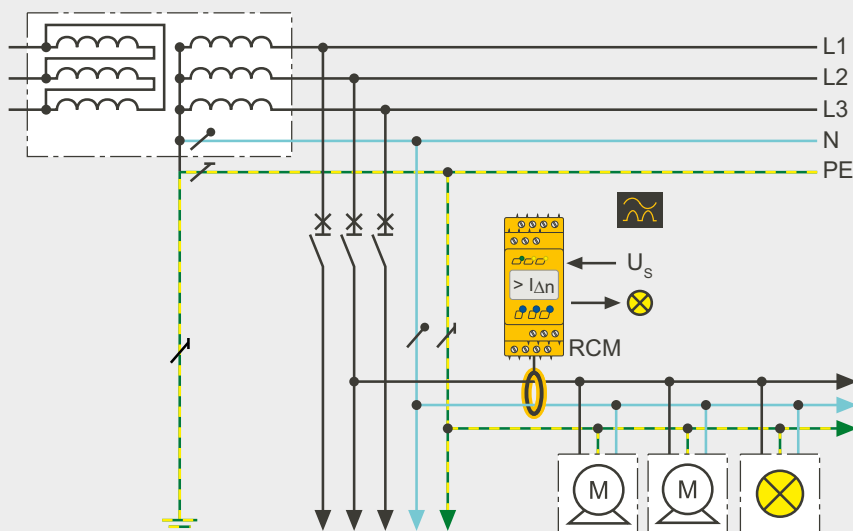

Monitoring of electrical loads

Measuring current transformers for residual current monitors and residual current monitoring systems



Dimensions	Type	Art. No.	Suitable for				
			RCM	RCMA		RCMS	
			RCM420	RCMA420	RCMA423	RCMS460 RCMS490	RCMS410
Internal diameter (mm)	CTAC... series, circular type						
ø 20	CTAC20	B98110005	✓	—	—	✓	✓
ø 35	CTAC35	B98110007	✓	—	—	✓	✓
ø 60	CTAC60	B98110017	✓	—	—	✓	✓
ø 120	CTAC120	B98110019	✓	—	—	✓	✓
ø 210	CTAC210	B98110020	✓	—	—	✓	✓



Internal diameter (mm)	CTUB101-CTBC... series, circular type, AC/DC sensitive, DC ±12 V						
ø 20	CTUB101-CTBC20	B78120010	—	✓	✓	(✓) ¹⁾	—
	CTUB101-CTBC20P	B78120020	—	✓	✓	(✓) ¹⁾	—
ø 35	CTUB101-CTBC35	B78120012	—	✓	✓	(✓) ¹⁾	—
	CTUB101-CTBC35P	B78120022	—	✓	✓	(✓) ¹⁾	—
ø 60	CTUB101-CTBC60	B78120014	—	✓	✓	(✓) ¹⁾	—
	CTUB101-CTBC60P	B78120024	—	✓	✓	(✓) ¹⁾	—
ø 120	CTUB101-CTBC120	B78120016	—	—	✓	(✓) ¹⁾	—
	CTUB101-CTBC120P	B78120026	—	—	✓	(✓) ¹⁾	—
ø 210	CTUB101-CTBC210	B78120018	—	—	✓	(✓) ¹⁾	—
	CTUB101-CTBC210P	B78120028	—	—	✓	(✓) ¹⁾	—

¹⁾ Only recommended for retrofitting when an AN420 power supply unit is available.



Internal diameter (mm)	CTUB102-CTBC... series, circular type, AC/DC sensitive, DC 24 V						
ø 20	CTUB102-CTBC20	B78120011	—	—	—	✓	✓
	CTUB102-CTBC20P	B78120021	—	—	—	✓	✓
ø 35	CTUB102-CTBC35	B78120013	—	—	—	✓	✓
	CTUB102-CTBC35P	B78120023	—	—	—	✓	✓
ø 60	CTUB102-CTBC60	B78120015	—	—	—	✓	✓
	CTUB102-CTBC60P	B78120025	—	—	—	✓	✓
ø 120	CTUB102-CTBC120	B78120017	—	—	—	✓	✓
	CTUB102-CTBC120P	B78120027	—	—	—	✓	✓
ø 210	CTUB102-CTBC210	B78120019	—	—	—	✓	✓
	CTUB102-CTBC210P	B78120029	—	—	—	✓	✓



Dimensions	Type	Art. No.
Internal diameter (mm)		
ø 26	CTBS25	B98120060



Internal diameter (mm)		
ø 18	RCMB131-01	B94042131



Internal diameter (mm)		
ø 15	RCMB131-02	B94042132



Internal diameter (mm)	CTAC... series, circular type	
ø 15	RCMB132-01	B94042136
	Mounting foot MCCT20	B91080111

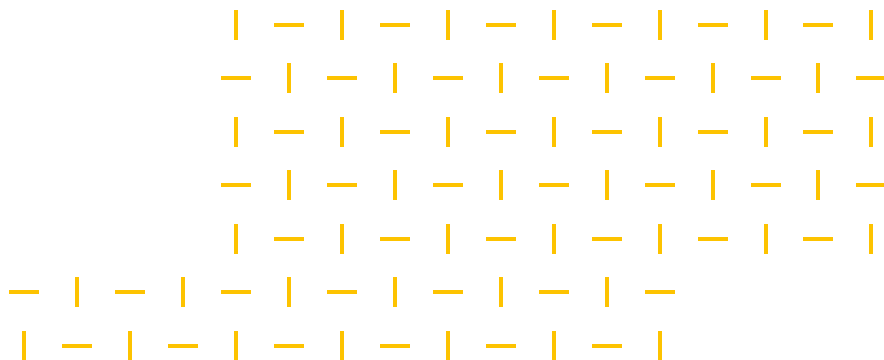

Dimensions	Type	Art. No.	Suitable for							
			RCM	RCMA		RCMS				
			RCM420	RCMA420	RCMA423	RCMS460 RCMS490	RCMS410			
Inside diameter (mm)	WR... series, rectangular type									
70 x 175 (W x H)	WR70x175S	B977738	✓	—	—	✓	✓			
	WR70x175SP	B911790	✓	—	—	✓	✓			
115 x 305 (W x H)	WR115x305S	B911739	✓	—	—	✓	✓			
	WR115x305SP	B911791	✓	—	—	✓	✓			
150 x 350 (W x H)	WR150x350S	B911740	✓	—	—	✓	✓			
	WR150x350SP	B911792	✓	—	—	✓	✓			
200 x 500 (W x H)	WR200x500S	B911763	✓	—	—	✓	✓			
	WR200x500SP	B911793	✓	—	—	✓	✓			



Inside diameter (mm)	WS... series, rectangular type, split-core									
20 x 30 (W x H)	WS20x30	B98080601	✓	—	—	✓	✓			
50 x 80 (W x H)	WS50x80	B98080603	✓	—	—	✓	✓			
80 x 120 (W x H)	WS80x120	B98080606	✓	—	—	✓	✓			



Length A Measuring current transformer	WF... series, flexible									
170	WF170	B 7808 0201	✓	—	—	✓	✓			
250	WF250	B 7808 0203	✓	—	—	✓	✓			
500	WF500	B 7808 0205	✓	—	—	✓	✓			
800	WF800	B 7808 0207	✓	—	—	✓	✓			
1200	WF1200	B 7808 0209	✓	—	—	✓	✓			
1800	WF1800	B 7808 0221	✓	—	—	✓	✓			



Approvals: UL approval, with the exception of WS, LR series

Other measuring current transformers on request



W...-S... series



WS...S series

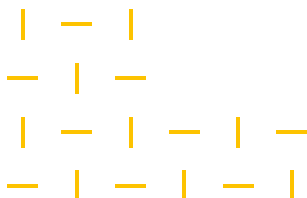



Bender monitoring systems – seamless communication

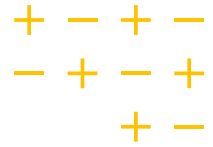

Modern communication

Since increasing demands are placed on communication capability, data transparency, and flexibility, the use of modern field bus and network technologies has become indispensable in the automation of electrical installations.

For instance, messages about operating states, warnings and messages about malfunctions received via the web or a network help to make power supply systems more transparent. At the same time they allow fast responses to critical operating states. In addition, important messages can be transferred via text message or e-mail to the mobile phones or laptops of service personnel. Early information about the location and cause of a fault allows time and cost-efficient deployment of service personnel and helps avoid a possible installation failure or damage to expensive devices.

Electrical Safety Management

Under the heading "Electrical Safety Management" Bender offers comprehensive solutions for the electrical safety of power supply systems in all areas. Carefully matched products and systems with innovative measuring equipment, communication solutions for the visualisation of data from Bender monitoring systems as well as the easy connection to field bus and SCADA systems (supervisory control and data acquisition systems) provide the highest level of safety, economic efficiency and transparency. The range of products is completed by comprehensive services, which are provided for the entire service life of the products.



COM465IP

Condition monitor with integrated gateway for the connection of Bender devices to Ethernet TCP/IP networks









COMTRAXX® CP9...-I

The COMTRAXX® CP9...-I series includes a condition monitor with web interface and a display that is available in various sizes. All Bender devices can be connected via integrated interfaces.



Accessories for residual current monitors and residual current monitoring systems

Products							
		COMTRAXX® COM465IP	COMTRAXX® COM465DP	COMTRAXX® COM465ID	COMTRAXX® COM463BC	COMTRAXX® CP9...-I	DI-1DL
Application		Condition monitor/ gateway	Condition monitor/ PROFIBUS gateway	Condition monitor/ gateway	Condition monitor/ gateway	Condition monitor/ gateway	Interface repeater for BMS bus
Functions	Protocol input	BMS / BCOM / Modbus RTU/ TCP	BMS / BCOM / Modbus RTU/ TCP	isoData/Modbus TCP	BMS (external) / BCOM	BMS (internal) / BCOM / Modbus RTU/TCP	—
	Protocol output	Ethernet / Modbus RTU/ TCP / SNMP	Ethernet / Modbus RTU/ TCP / SNMP / PROFIBUS DP	Ethernet / Modbus TCP / OPC-UA ⁵⁾	Ethernet	Ethernet / Modbus RTU/ TCP / SNMP	RS-485
	Display	LED	LED	LED	LED	Display in 7" or 15.6"	RS-485
	Alarm messages	✓ ^{1,2)}	✓ ^{1,2)}	✓ ^{1,2)}	✓ ^{1,2)}	✓ ^{1,2,3)}	—
	Measured values	✓ ^{1,2)}	✓ ^{1,2)}	✓ ^{1,2)}	✓ ^{1,2)}	✓ ^{1,2,3)}	—
	Device parameter setting	✓ ¹⁾	✓ ¹⁾	✓ ¹⁾	—	✓ ¹⁾	—
	Alarm list	✓ ¹⁾	✓ ¹⁾	✓ ¹⁾	—	✓ ^{1,3)}	—
	History memory	✓ ¹⁾	✓ ¹⁾	✓ ¹⁾	—	✓ ¹⁾	—
	Diagrams	✓ ¹⁾	✓ ¹⁾	✓ ¹⁾	—	✓ ^{1,3)}	—
	Visualisation	✓ ¹⁾	✓ ¹⁾	✓ ¹⁾	—	✓ ¹⁾	—
	E-mail notification	✓ ^{1,4)}	✓ ^{1,4)}	✓ ^{1,4)}	✓ ^{1,4)}	✓ ^{1,4)}	—
	Device tests	✓ ^{1,2)}	✓ ^{1,2)}	✓ ^{1,2)}	—	✓ ^{1,2)}	—
	PEM... and energy meter support	✓ ¹⁾	✓ ¹⁾	✓ ¹⁾	—	✓ ¹⁾	—
SNMP	✓ ¹⁾	✓ ¹⁾	✓ ¹⁾	—	✓ ¹⁾	—	
Data logger	✓ ¹⁾	✓ ¹⁾	✓ ¹⁾	—	✓ ¹⁾	—	
Supply voltage U _s	AC/DC 24...240 V, DC 24 V	AC/DC 24...240 V, DC 24 V	AC/DC 24...240 V	AC/DC 24...240 V	DC 24 V	AC 85...260 V, 50...60 Hz	

¹⁾ Available functions on the web server – accessible by means of a PC with a browser,

²⁾ Available via the protocol

³⁾ On the device-internal LC display

⁴⁾ TLS/SSL support

Ordering information

Supply voltage/frequency range U _s	Supply voltage/frequency range U _s for UL applications	Power consumption	Type	Art. No.
AC/DC 24...240 V, 50...60 Hz	—	≤ 6.5 VA, ≤ 4 W	COM465IP-230V	B95061065
DC 24	—	≤ 3 W	COM465IP-24V	B95061066
AC/DC 24...240 V, 50...60 Hz	—	≤ 6.5 VA, ≤ 4 W	COM465DP-230V	B95061060
DC 24	—	≤ 3 W	COM465DP-24V	B95061061
AC/DC 24...240 V, 50...60 Hz	—	≤ 6.5 VA/ ≤ 4 W	COM465ID-230V	B95061070
24...240 V, 50...60 Hz	—	≤ 9.6 VA/ ≤ 4 W	COM463BC-230V	B95061051
DC 24 V, < 15 W	—	—	CP9...-I / 7"	B95061031
AC 100...240 V, < 30 W	—	—	CP9...-I / 15"	B95061033
AC 85...260 V, 50...60 Hz	—	0.1 A/7 W	DI-1DL (Interface repeater for BMS bus)	B95012047

Function modules for COM465IP, COM465DP and COM465ID

Application	Function module (software licence)	Art. No.
Individual texts for all devices/channels, device failure monitoring, e-mail in the event of an alarm	Function module A	included
Modbus TCP server for max. 98 * 139 BMS nodes as well as BCOM and universal measuring devices, SNMP server	Function module B	B75061012
Parameter setting of BMS devices as well as BCOM and universal measuring devices	Function module C	included
Visualisation of Bender systems, system visualisation	Function module D	B75061014
Virtual devices	Function module E	included
Integration of third-party devices	Function module F	B75061016

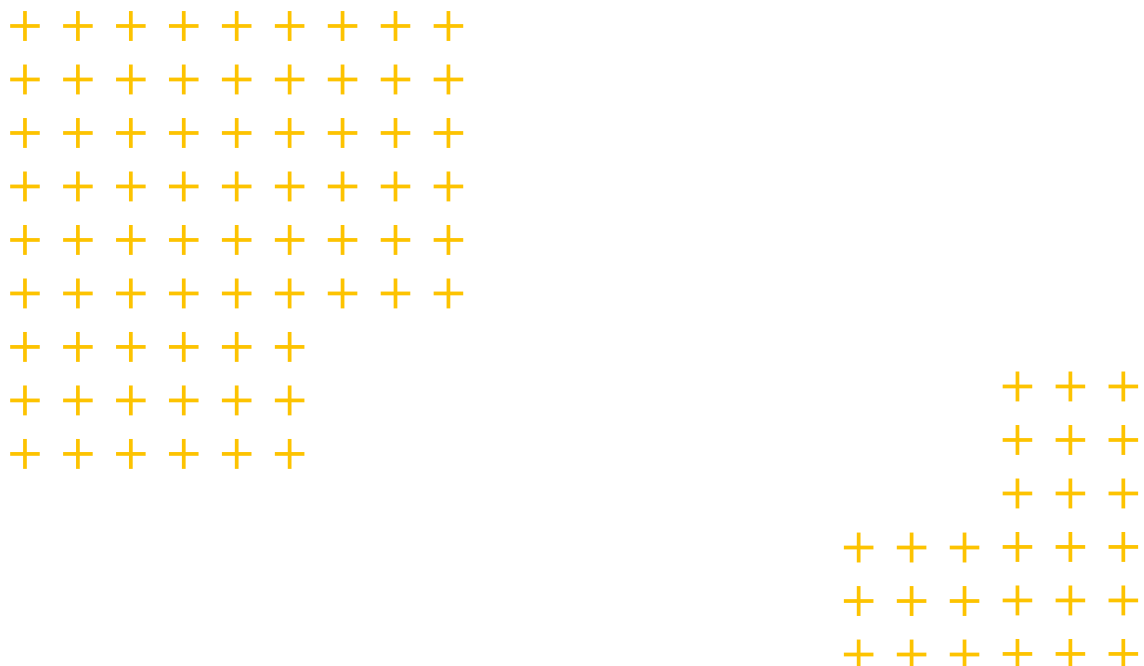

Support during all stages remote, by phone, on site

From planning to modernisation – Our extensive know-how is at your disposal during all project phases.

Furthermore, with our first-class service we guarantee maximum safety for your electrical installation. We offer services ranging from support over telephone to repairs and on-site service – with modern measuring devices and competent employees.

Be on the safe side:

- High availability of your installation thanks to fast reaction to fault messages
- Increased return on your capital expenditure (CapEx) via optimised maintenance processes
- Targeted reduction of the operating expenditure (OpEx) due to reduced downtimes and shorter service visits

- Support for your predictive installation monitoring and regular checks of your installation/power quality/monitoring devices
- Automatic checks, analysis, correction, new settings/updates
- Competent assistance with parameter changes and updates

Bender Remote Assist

Bender Remote Assist offers you support via remote access, high-quality service and advice for your challenging task of ensuring consistently high safety in your installations.

For, in many cases service visits, fault clearance but also analyses and controls can be carried out remotely – without the expense of time and money that an on-site visit of a technician entails.

This fast, efficient help and advice by our expert network allows the highest possible availability of your installation.

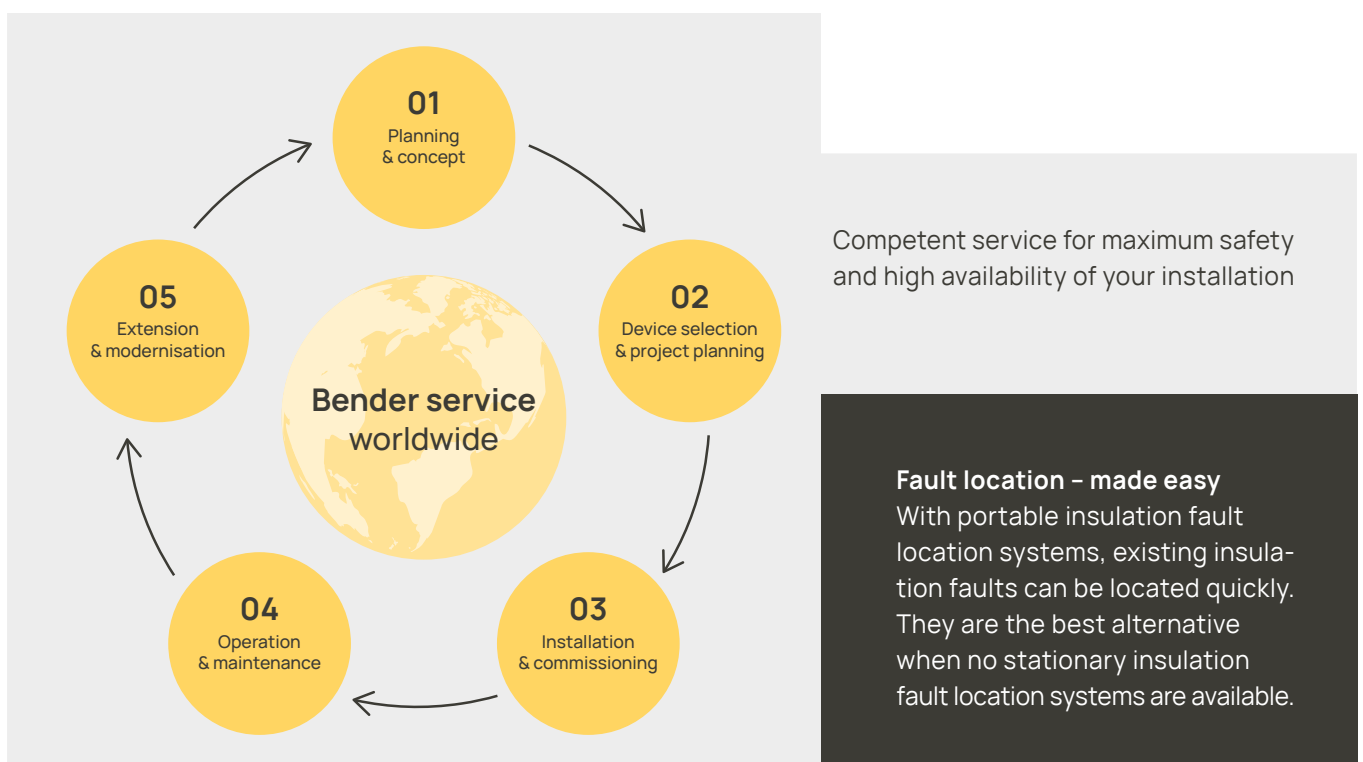

POWERSCOUT®

Maximum transparency with minimum expenditure

Moisture, deterioration, dirt, mechanical damage or faults due to the impact of current, voltage and temperature cause malfunctions in every electrical installation. The web-based software solution POWERSCOUT® helps you detect malfunctions at an early stage and eliminate the causes in an economically reasonable way. This guarantees a high safety level for the installation as well as high operational reliability, and it reduces costs.

Analysis – as individual as your installation – as simple as possible

Predictive maintenance prevents downtimes, reduces costs and required staff hours. POWERSCOUT® informs you about the condition of your electrical installation at all times, since the informative visualisations with flexible dashboards can be retrieved via any display device: smartphone, laptop, computer. On request, POWERSCOUT® sends you graphically processed reports at specified intervals.

Continuous monitoring instead of random tests

Manual data acquisition is time consuming, error-prone and only provides random results. With POWERSCOUT® you have the complete data of your installation at your disposal at any time since all measured values are automatically and continuously saved. Your data is stored reliably and remains available for years.

Basis for periodic verification

The automated POWERSCOUT® report on residual currents forms the basis for measuring without switch-off in accordance with IEC 60364-6. In order to maintain the correct status for electrical installations and stationary electrical equipment, periodic verification must be carried out.

This can be ensured, for example, when the installation is monitored continuously by qualified personnel. Here, it is a smart move to rely on continuous monitoring with multi-channel residual current monitoring systems (RCMS) and an evaluation adapted to the installation (COMTRAXX® series). The automatic POWERSCOUT® reports based on this monitoring enable the qualified person in charge to adjust the times when the insulation test shall be performed as part of the periodic verification.

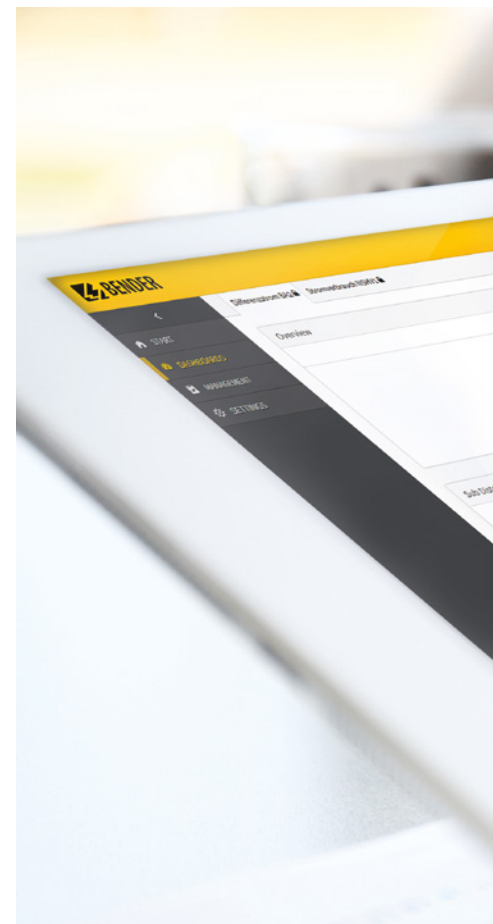

POWERSCOUT®: The web-based software solution for analysis, predictive maintenance, and reporting.

Analysis

- Recording insulation values continuously
- Recognising connections and optimising maintenance
- Cross-installation evaluation possibilities
- Access from any place
- Supporting investment decisions

Predictive maintenance

- Higher availability
- Continuous monitoring

- Early detection of gradually developing insulation faults
- Early detection and reporting of short-time insulation degradation
- Lower costs incurred due to unexpected malfunctions and shutdowns

Reports

- Historical comparisons
- Safe storage of measured values
- Event and alarm statistics

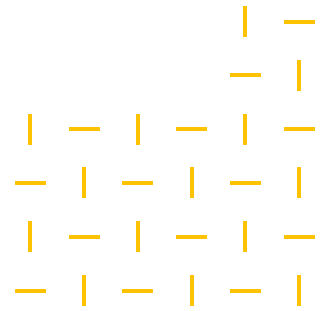



Bender. Making your world safe.

Our world is networked on a global scale; it is digital, mobile and highly automated. And no matter whether in hospitals, in industry, inside or outside buildings, in power stations, in trains, underwater or underground: it never stands still and it is more dependent than ever on a reliable and, above all, safe electrical power supply.

And exactly that is our mission: We make electricity safe. With our technologies, we ensure that electricity is permanently available and guarantee faultless protection against the hazards of electric shock. We protect buildings, installations and devices, and therefore your investments and plans. But what we primarily protect are the lives of the people behind the electrical installations.



Mechanical and plant engineering



Oil, gas



Renewable energy



Healthcare



Public power supply network



Mobile power generation

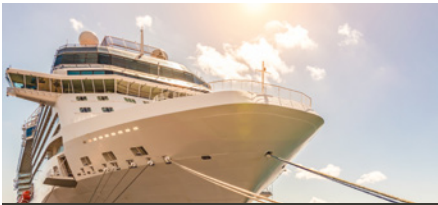

Ships and ports



Railway



eMobility



Data centres



Mining



Battery energy storage systems (BESS)

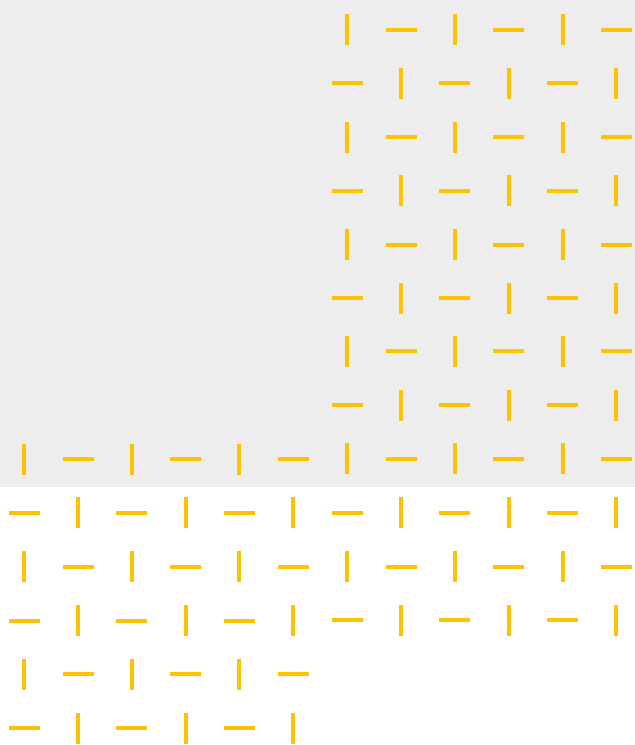

Bender GmbH & Co. KG

Londorfer Straße 65
35305 Grünberg
Germany

Tel.: +49 6401 807-707
info@bender.de
www.bender.de

Photos: AdobeStock (@LizFoster, @elen31, @Yeti Studio, @Ignacio Ferrándiz, @Gorodenkoff, @Jose Luis Stephens, @koldunova, @totojang1977, @kbarzycki, @stefan77, @Nancy Pauwels, @TeacherPhoto, @Southworks, @2ragon, @agnormark, @malp), Fotolia (@opolja) and Bender archives.

2123en / 11.2023 / © Bender GmbH & Co. KG, Germany – subject to change! The specified standards take into account the version valid at the time of printing.

